



■ Features

- Three-Phase 340 ~ 550VAC wide range input (Dual phase operation possible)
- Width only 85.5mm
- Built-in active PFC function compliance to EN61000-3-2
- High efficiency 93% and low power dissipation
- Protections: Short circuit / Overload / Over voltage / Over temperature
- Cooling by free air convection
- Built-in constant current limiting circuit
- Can be installed on DIN rail TS-35/7.5 or 15
- UL508(industrial control equipment)approved
- EN61000-6-2(EN50082-2) industrial immunity level
- Optional DC OK relay contact
- 3 years warranty

■ Applications

- Industrial control system
- Semiconductor fabrication equipment
- Factory automation
- Electro-mechanical apparatus

■ Description

TDR-480 is one economical slim 480W DIN rail power supply series, adapt to be installed on TS-35/7.5 or TS-35/15 mounting rails. The body is designed 85.5mm in width, which allows space saving inside the cabinets. The entire series adopts the full range AC input from 3 ψ 340VAC to 550VAC (Dual Phase operation possible) and conforms to EN61000-3-2, the norm the European Union regulates for harmonic current. TDR-480 is designed with metal housing that enhances the unit's power dissipation. With working efficiency up to 93 %, the entire series can operate at the ambient temperature between -20°C and 70°C under air convection. It is equipped with constant current mode for overload protection, fitting various inductive or capacitive applications. The complete protection functions and relevant certificates for industrial control apparatus (UL508, IEC 60950-1 CB approved by UL.) make TDR-480 a very competitive power supply solution for industrial applications.

■ Model Encoding

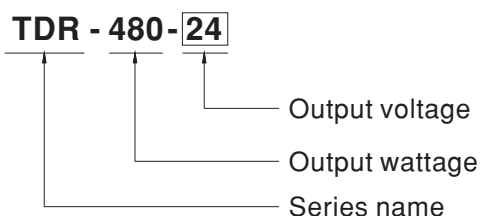



SPECIFICATION

MODEL		TDR-480-24	TDR-480-48	
OUTPUT	DC VOLTAGE	24V	48V	
	RATED CURRENT	20A	10A	
	CURRENT RANGE	0 ~ 20A	0 ~ 10A	
	RATED POWER	480W	480W	
	RIPPLE & NOISE (max.) Note.2	150mVp-p	150mVp-p	
	VOLTAGE ADJ. RANGE	24 ~ 28V	48 ~ 55V	
	VOLTAGE TOLERANCE Note.3	± 1.0%	± 1.0%	
	LINE REGULATION	± 0.5%	± 0.5%	
	LOAD REGULATION	± 1.0%	± 1.0%	
	SETUP, RISE TIME	1200ms, 60ms/400VAC 800ms, 60ms/500VAC at full load		
HOLD UP TIME (Typ.)	20ms / 400VAC 20ms / 500VAC at full load			
INPUT	VOLTAGE RANGE Note.4	Three-Phase 340 ~ 550VAC (Dual phase operation possible) 480 ~ 780VDC		
	FREQUENCY RANGE	47 ~ 63Hz		
	POWER FACTOR (Typ.)	PF ≥ 0.9/400VAC PF ≥ 0.88/500VAC at full load		
	EFFICIENCY (Typ.)	92.5%	93%	
	AC CURRENT (Typ.)	0.85A/400VAC 0.7A/500VAC		
	INRUSH CURRENT (Typ.)	COLD START 50A		
	LEAKAGE CURRENT	<3.5mA / 530VAC		
PROTECTION	OVERLOAD	105 ~ 130% rated output power Protection type : Constant current limiting, unit will shut down after 3 sec. ,re-power on to recover		
	OVER VOLTAGE	29 ~ 33V	56 ~ 65V	
	OVER TEMPERATURE	Shut down o/p voltage, recovers automatically after temperature goes down		
ENVIRONMENT	WORKING TEMP. Note.5	-30 ~ +70°C (Refer to "Derating Curve")		
	WORKING HUMIDITY	20 ~ 95% RH non-condensing		
	STORAGE TEMP., HUMIDITY	-40 ~ +85°C, 10 ~ 95% RH		
	TEMP. COEFFICIENT	± 0.03%/°C (0 ~ 50°C)		
	VIBRATION	Component:10 ~ 500Hz, 2G 10min./1cycle, 60min. each along X, Y, Z axes; Mounting: Compliance to IEC60068-2-6		
SAFETY & EMC (Note 4)	SAFETY STANDARDS	UL508, IEC60950-1 CB approved by UL		
	WITHSTAND VOLTAGE	I/P-O/P:3KVAC I/P-FG:2KVAC O/P-FG:0.5KVAC O/P-DC OK(optional):0.5KVAC		
	ISOLATION RESISTANCE	I/P-O/P, I/P-FG, O/P-FG:>100M Ohms / 500VDC / 25°C / 70% RH		
	EMC EMISSION	Parameter	Standard	Test Level / Note
		Conducted	EN55032(CISPR32) / EN61204-3	Class B
		Radiated	EN55032(CISPR32) / EN61204-3	Class B
		Harmonic Current	EN61000-3-2	Class A
		Voltage Flicker	EN61000-3-3	-----
	EMC IMMUNITY	EN55024 , EN60601-1-2, EN61204-3		
		Parameter	Standard	Test Level / Note
ESD		EN61000-4-2	Level 4, 15KV air ; Level 4, 8KV contact	
Radiated Field		EN61000-4-3	Level 3	
EFT / Burst		EN61000-4-4	Level 3	
Surge		EN61000-4-5	Level 4, 2KV / Line-Line, Level 4, 4KV/ Line-Earth	
Conducted		EN61000-4-6	Level 3	
Magnetic Field		EN61000-4-8	Level 4	
Voltage Dips and Interruptions	EN61000-4-11	> 95% dip 0.5 periods, 30% dip 25 periods > 95% interruptions 250 periods		
OTHERS	MTBF	391.7K hrs min. Telcordia SR-332(Bellcore) ; 108.2K hrs min. MIL-HDBK-217F (25°C)		
	DIMENSION	85.5*125.2*128.5mm (W*H*D)		
	PACKING	1.51Kg ; 8pcs/13Kg/1.16CUFT		
NOTE	<p>1. All parameters NOT specially mentioned are measured at 400VAC input, rated load and 25°C of ambient temperature.</p> <p>2. Ripple & noise are measured at 20MHz of bandwidth by using a 12" twisted pair-wire terminated with a 0.1uf & 47uf parallel capacitor.</p> <p>3. Tolerance : includes set up tolerance, line regulation and load regulation.</p> <p>4. Dual phase operation is allowed under certain derating to output load. Please refer to derating curves for details.</p> <p>5. Installation clearances : 40mm on top, 20mm on the bottom, 5mm on the left and right side are recommended when loaded permanently with full power. In case the adjacent device is a heat source, 15mm clearance is recommended.</p> <p>6. The power supply is considered as an independent unit, but the final equipment still need to re-confirm that the whole system complies with the EMC directives. For guidance on how to perform these EMC tests, please refer to "EMI testing of component power supplies." (as available on http://www.meanwell.com)</p>			

Block Diagram

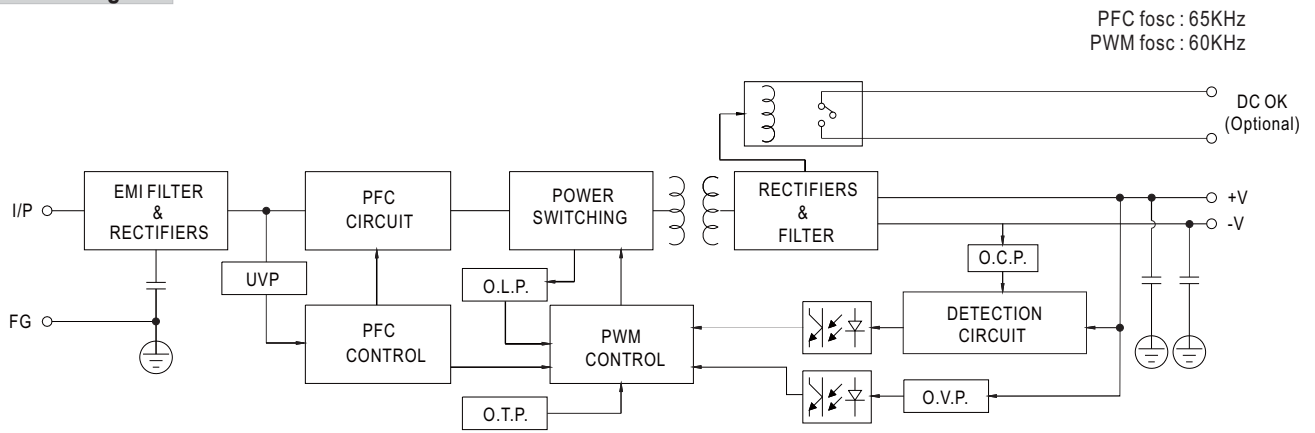

Derating Curve

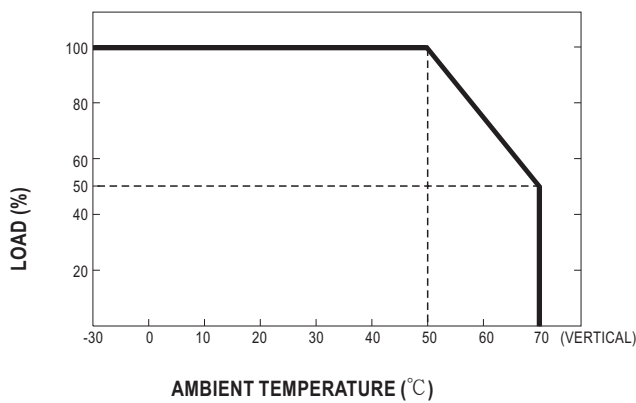

Output derating VS input voltage

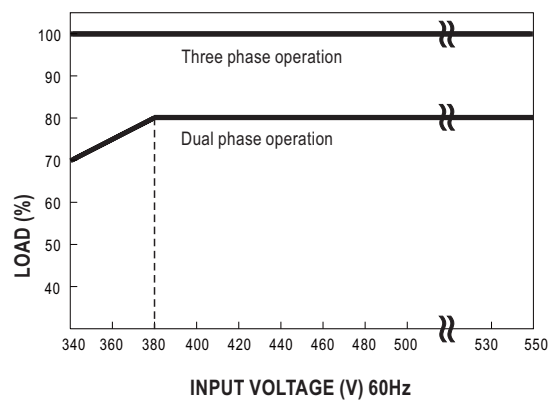

DC OK Relay Contact (Optional)

Contact Close	PSU turns on / DC OK.
Contact Open	PSU turns off / DC Fail.
Contact Ratings (max.)	60VDC/0.3A, 30VDC/1A, 30VAC/0.5A resistive load.

Control Pin (Optional) : DINKLE ECH250R-02P or equivalent (CN25)

Pin No.	Assignment	Mating Housing	Wire Diameter
1,2	DC OK Relay Contact	Dinkle ESC250V-02P or equivalent (Including in the package)	0.081~0.517mm ² (20~28AWG)

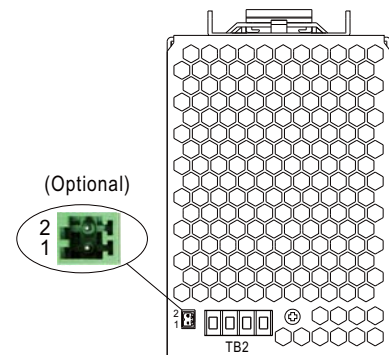

※ Please contact MEAN WELL for more details.

Mechanical Specification

Case No.984E Unit:mm

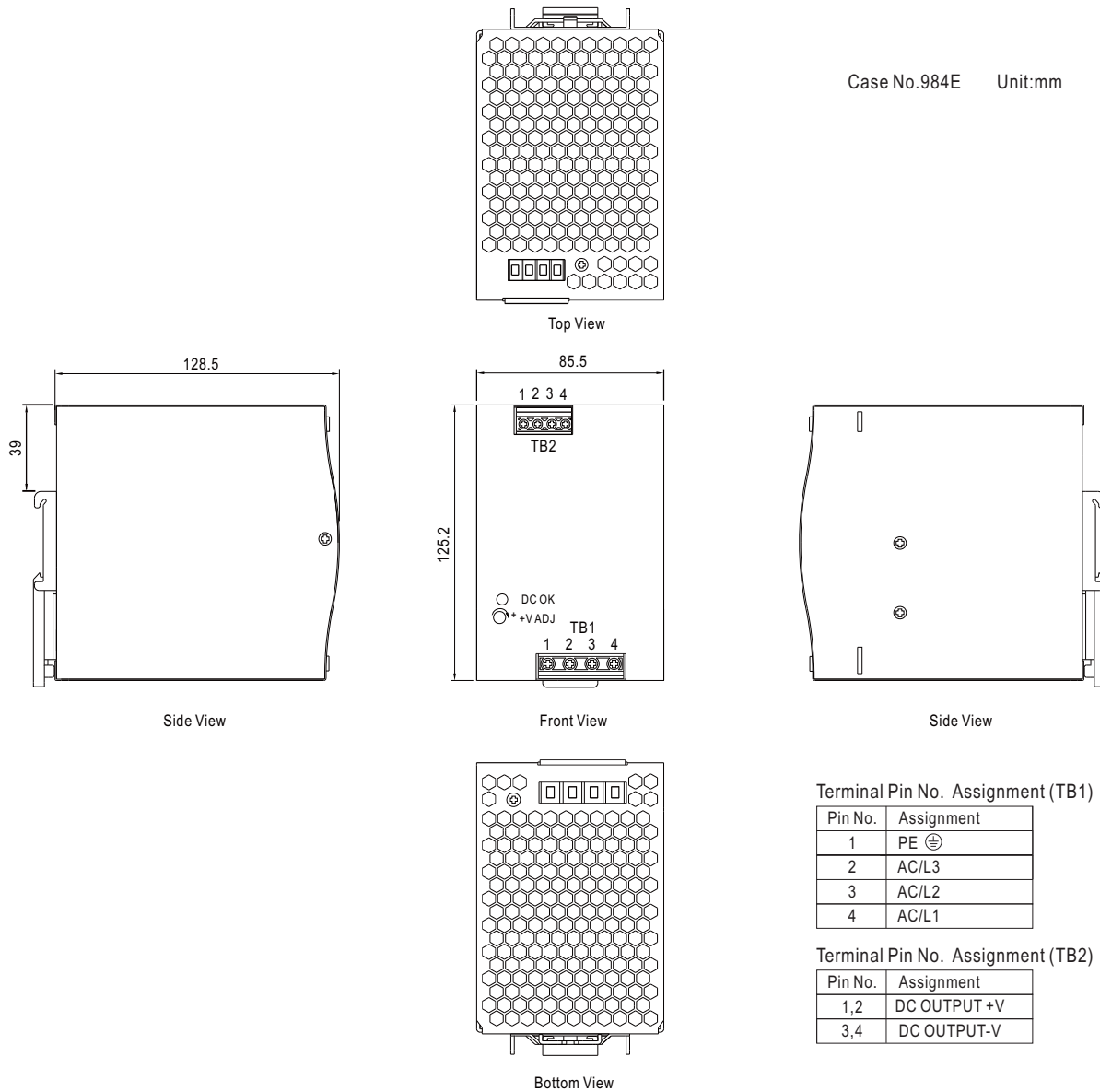

Installation Instruction

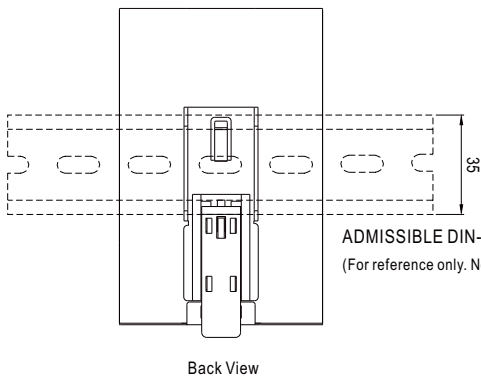

ADMISSIBLE DIN-RAIL: TS35/7.5 OR TS35/15
(For reference only. Not included with unit.)

This series fits DIN rail TS35/7.5 or TS35/15.
For installation details, please refer to the Instruction manual.

Installation Manual

Please refer to : <http://www.meanwell.com/manual.html>